

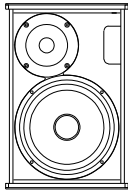
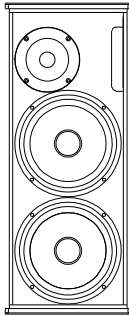
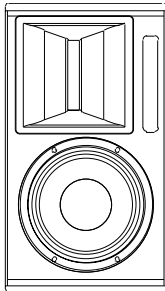

product line-up spring 2011

T-series		features
TS3		<ul style="list-style-type: none">● 1" soft-dome tweeter + 6.5" woofer● 67Hz. – 20.000Hz. (+/- 3dB)● SPL program/peak 109dB / 115dB● Signal Integrity Sensing™ pre-wired● Dispersion H 90° x V 60°● Omnimount™ mounting points, bracket (option)
TS7		<ul style="list-style-type: none">● 1" soft-dome tweeter + double 6.5" woofer● 66Hz. – 20.000Hz. (+/- 3dB)● SPL program/peak 115dB / 121dB● Signal Integrity Sensing™ pre-wired● Dispersion H 90° x V 40°● Omnimount™ mounting points, bracket (option)
V-series		features
VR8		<ul style="list-style-type: none">● RBN401 pro-ribbon HF driver with 8" woofer● 74Hz. – 20.000Hz. (+/- 3dB)● SPL program/peak (nom.) 120dB / 125dB● Signal Integrity Sensing™ pre-wired● Revolvable 90°x40°/ 40°x90° HempHorn™ wave-guide● Asymmetric enclosure for multi-angle mounting● Durotect™ scratch-resistant coating

V-series continued

features

VR12
VR12i
VR12M

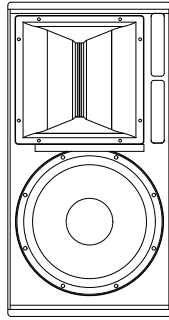

- RBN601 pro-ribbon HF driver with 12" woofer
- 60Hz. – 20.000Hz. (+/- 3dB)
- SPL program/peak (nom.) 127dB / 132dB
- Signal Integrity Sensing™ pre-wired
- Revolvable 90°x40°/40°x90° HempHorn™ wave-guide
- Asymmetric enclosure for multi-angle mounting
- Durotect™ scratch-resistant coating
- All NeoDymium drivers

*VR12i without handles and stand mount adapter
VR12M with "mirrored" baffle, for floor monitor use*

VR12/60
VR12/60i
VR12/60M

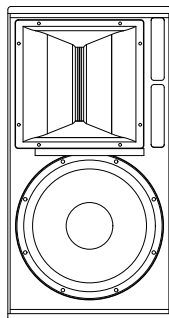

- RBN601 pro-ribbon HF driver with 12" woofer
- 60Hz. – 20.000Hz. (+/- 3dB)
- SPL program/peak (nom.) 128dB / 133dB
- Signal Integrity Sensing™ pre-wired
- Non-revolvable 60°x30° HempHorn™ wave-guide
- Asymmetric enclosure for multi-angle mounting
- Durotect™ scratch-resistant coating
- All NeoDymium drivers

*VR12/60i without handles and stand mount adapter
VR12/60M with "mirrored" baffle, for floor monitor use*

S-series

features

SR9

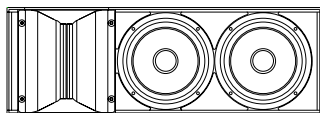

- RBN401 pro-ribbon HF driver with 2x 5" woofers
- 99Hz. – 20.000Hz. (+/-3dB)
- SPL program/peak (nom.) 117dB / 123dB
- Signal Integrity Sensing™ pre-wired
- Dispersion H 120 x V 15
- 16 ohms impedance
- Very compact enclosure for minimal sightline obstruction
- Durotect™ scratch-resistant coating.

QR18

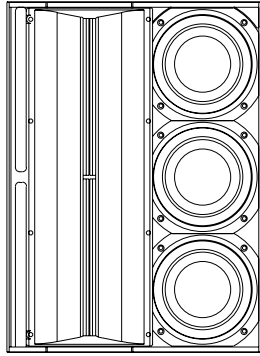

- RBN1801 pro-ribbon HF driver with 3 x 6.5" woofers
- All NeoDymium drivers
- 74Hz. – 20.000Hz. (+/-3dB)
- SPL program/peak (nom.) 123dB / 144dB
- Signal Integrity Sensing™ pre-wired
- 90° HempHorn™ wave-guide
- Column length 50,6 cm / 19.9 in.
- Durotect™ scratch-resistant coating

QM18

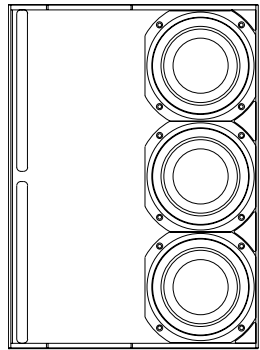

- 3x 6.5" NeoDymium woofers
- 74Hz. – 1.000Hz. (+/-3dB)
- SPL program/peak (nom.) 123dB / 129dB
- Signal Integrity Sensing™ pre-wired
- Column length 50,6 cm / 19.9 in.
- Durotect™ scratch-resistant coating

QR36

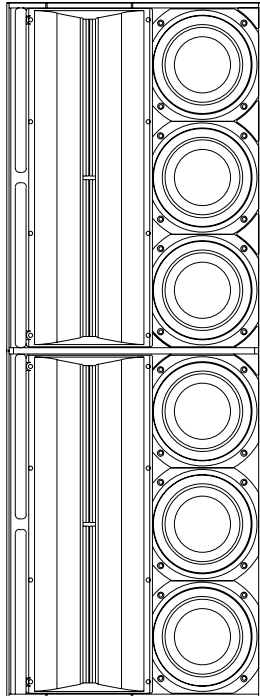

- Double RBN1801 pro-ribbon HF drivers with 6x 6.5" woofers
- All NeoDymium drivers
- 74Hz. – 20.000Hz. (+/-3dB)
- SPL program/peak (nom.) 129dB / 150dB
- Signal Integrity Sensing™ pre-wired
- 90° HempHorn™ wave-guide
- Column length 100,6 cm / 39.6 in.
- Durotect™ scratch-resistant coating

QM36

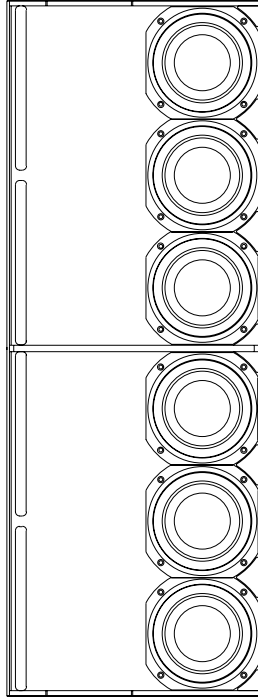

- 6x 6.5" NeoDymium woofers
- 74Hz. – 20.000Hz. (+/-3dB)
- SPL program/peak (nom.) 129dB / 135dB
- Signal Integrity Sensing™ pre-wired
- Column length 100,6 cm / 39.6 in.
- Durotect™ scratch-resistant coating

QB363

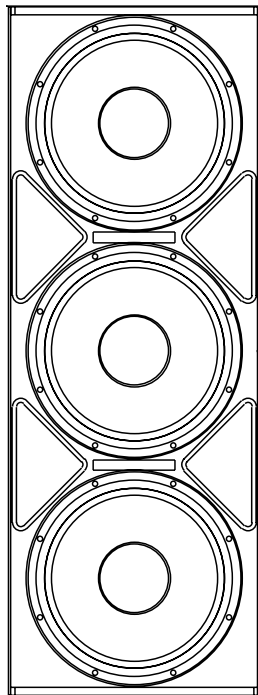

- 3x 12" vented all Neodymium woofers
- 45Hz. – 250Hz. (+/-3dB)
- SPL program/peak (nom.) 130dB / 135dB
- Signal Integrity Sensing™ pre-wired
- Column length 100,6 cm / 39.6 in.
- LMF bass module for QR-arrays
- Durotect™ scratch-resistant coating

LR7

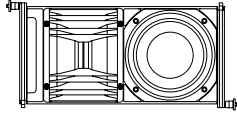

- RBN401 pro-ribbon HF driver with exceptional intelligibility and “throw”
- All Neodymium drivers
- 74Hz. – 20.000Hz. (+/-3dB)
- SPL program/peak (nom.) 119dB / 124dB
- Signal Integrity Sensing™ pre-wired
- “Morpher” lens in 120°x15° ALrad™ wave-guide
- Durotect™ scratch-resistant coating

LR7/90

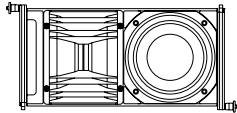

- RBN401 pro-ribbon HF driver with exceptional intelligibility and “throw”
- All Neodymium drivers
- 74Hz. – 20.000Hz. (+/-3dB)
- SPL program/peak (nom.) 119dB / 125dB
- Signal Integrity Sensing™ pre-wired
- “Morpher” lens in 90°x15° ALrad™ wave-guide
- Durotect™ scratch-resistant coating

LR7B

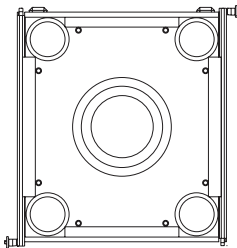

- Stackable and flyable with LR7 or in separate arrays
- Single Neodymium 12” driver for excellent performance-to-weight ratio
- Double-tuned concentric band-pass design with high efficiency
- 46Hz. – 200Hz (+/- 3dB)
- SPL program/peak (nom.) 124dB / 129dB
- Signal Integrity Sensing™ pre-wired
- Durotect™ scratch-resistant coating

LR14

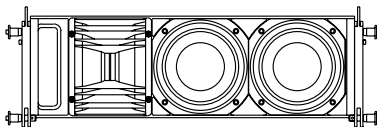

- RBN401 pro-ribbon HF driver with exceptional intelligibility and “throw”
- All Neodymium drivers
- 74Hz. – 20.000Hz. (+/-3dB)
- SPL program/peak (nom.) 123dB / 130dB
- Signal Integrity Sensing™ pre-wired
- “Morpher” lens in 120°x15° ALrad™ wave-guides
- Durotect™ scratch-resistant coating

LR14/90

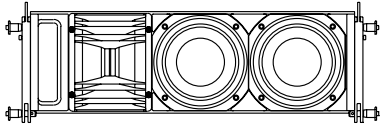

- RBN401 pro-ribbon HF driver with exceptional intelligibility and “throw”
- All Neodymium drivers
- 74Hz. – 20.000Hz. (+/-3dB)
- SPL program/peak (nom.) 123dB / 131dB
- Signal Integrity Sensing™ pre-wired
- “Morpher” lens in 90°x15° ALrad™ wave-guide
- Durotect™ scratch-resistant coating

LR14B

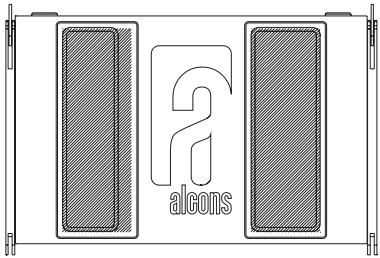

- Stackable and flyable with LR14 or in separate arrays
- Double Neodymium 12” drivers for excellent performance-to-weight ratio
- 46Hz. – 200Hz (+/- 3dB)
- SPL program/peak (nom.) 130dB / 135dB
- Signal Integrity Sensing™ pre-wired
- Durotect™ scratch-resistant coating

LR16

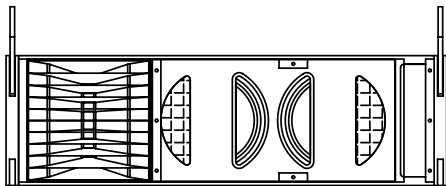

- RBN601 pro-ribbon HF with double 8” tapered woofers
- 70Hz. – 20.000Hz. (+/-3dB)
- SPL program/peak (nom.) 126dB / 135dB (HF)
- Signal Integrity Sensing™ pre-wired
- “Morpher” lens in 90°x10° HempHorn™ wave-guide
- Durotect™ scratch-resistant coating

LR16B

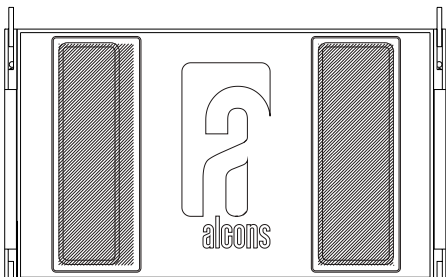

- Stackable and flyable with LR16 or in separate arrays
- Double Neodymium 15” drivers for excellent performance-to-weight ratio
- 46Hz. – 200Hz (+/- 3dB)
- SPL program/peak (nom.) 132dB / 137dB
- Signal Integrity Sensing™ pre-wired
- Durotect™ scratch-resistant coating

BF151
BF151i

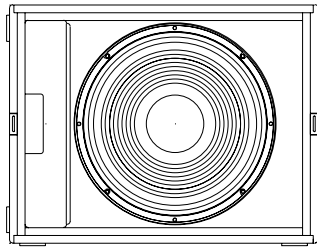

- Single 15" vented woofer (4 ohms)
- 42Hz - 300Hz (+/- 3dB)
- SPL program/peak (nom.) 127dB / 135dB
- Signal Integrity Sensing™ pre-wired
- Stand mount
- Double baffle board w. flush mount transducers
- Durotect™ scratch-resistant coating

BF151i without handles, castor wheels, cover and stand mount

BF181
BF181i

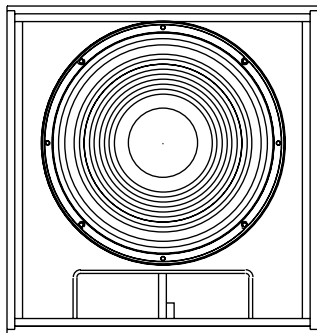

- Single 18" woofer (4 ohms)
- 33Hz - 200Hz (+/- 3dB)
- SPL program/peak (nom.) 128dB / 136dB
- Signal Integrity Sensing™ pre-wired
- Stand mount
- Double baffle board w. flush mount transducers
- Durotect™ scratch-resistant coating

BF181i without handles, castor wheels, cover and stand mount

BF302mkl
BF302mkl i

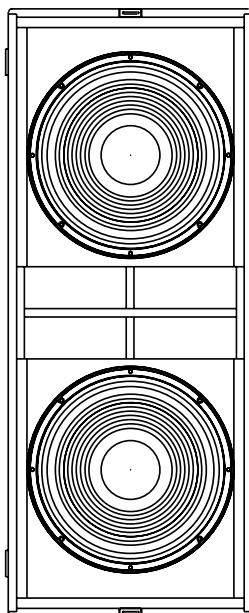

- Double 15" vented woofer
- 42Hz. - 300Hz. (+/- 3dB)
- SPL program/peak (nom.) 133dB / 141dB
- Signal Integrity Sensing™ pre-wired
- Large, centrally placed vent
- Double baffle board w. flush mount transducers
- Durotect™ scratch-resistant coating

BF302mkl i without handles, castor wheels and cover

BF362
BF362i

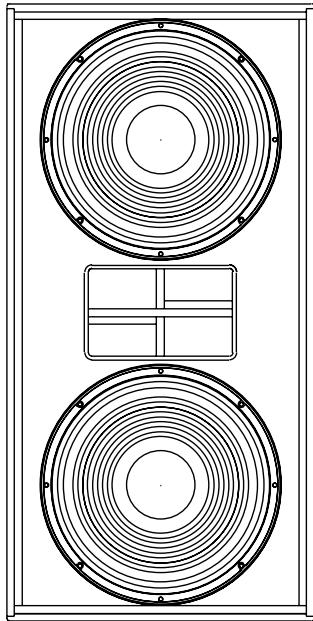

- Double 18" woofer
- 33 – 150Hz. (+/-3dB)
- SPL program/peak (nom.) 134 / 141dB
- Signal Integrity Sensing pre-wired
- Large, centrally placed vent
- Double baffle board w. flush mount transducers
- Durotect™ scratch-resistant coating

BF362i without handles, castor wheels and cover

BQ211
BQ211i

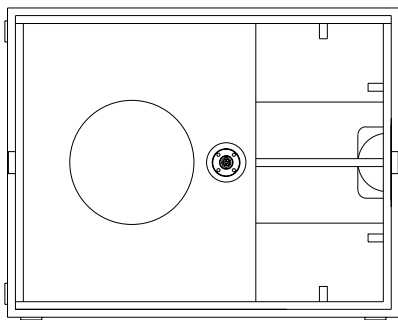

- Single 21" woofer with all-carbon cone (4 ohms)
- Double-tuned, quarter-wave pipe loading
- 33 – 150Hz. (+/-3dB)
- SPL peak (nom.) 145dB
- Improved breathing and low power compression
- Signal Integrity Sensing pre-wired
- Durotect™ scratch-resistant coating

BQ211i without handles, castor wheels and cover

BC543
BC543i

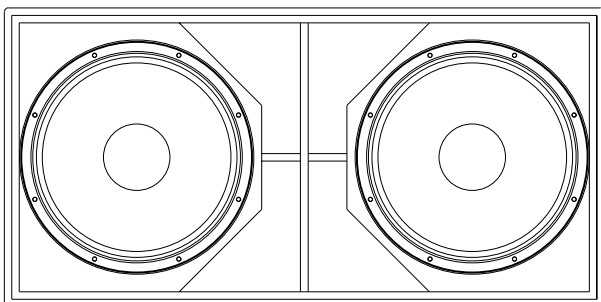

- Triple 18" woofer with 5.3" voice-coil and carbon cone
- Cardioid and hyper-cardioid projection control with DDP™
- X-Vent™ front port design breathing-optimisation
- Flank-Vent™ rear port design breathing-optimisation
- Signal Integrity Sensing™ pre-wired

The BC543 is available in standard version, or installation version. The BC543i ("install") comes without handles, castor wheels and cover.

ALC2
ALC2-ST

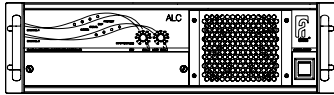

- 2 x 1.440W @ 2 ohms peak, Class G
- SDP Speaker Drive Processor™
- SIS Signal Integrity Sensing™, damping > 10.000
- ATCM Advanced Thermal and Clip Management™
- Data port for remote control network

ST version with stealth-hidden volume controls

ALC4
ALC4-ST

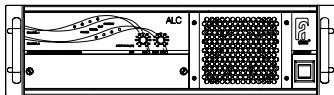

- 2 x 2.760W @ 2 ohms peak, Class G
- Dual power supply
- SDP Speaker Drive Processor™
- SIS Signal Integrity Sensing™, damping > 10.000
- ATCM Advanced Thermal and Clip Management™
- Data port for remote control network

ST version with stealth-hidden volume controls

ALC6
ALC6-ST

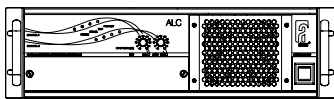

- 2 x 3.000W @ 4 ohms peak, Class G
- Dual power supply
- Optimized for "4 ohms and up" operation
- SDP Speaker Drive Processor™
- SIS Signal Integrity Sensing™, damping > 10.000
- ATCM Advanced Thermal and Clip Management™
- Data port for remote control network

ST version with stealth-hidden volume controls

DDP

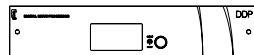

- ADC 24bit 96 kHz (27bit when stacked), DAC 24bit 96 kHz
- Freq response 10Hz..45kHz @-3 dB
- Display blue/white 128x64 dots
- Delay function: 1 to 294ms (100 meter) per channel
- User eq: Parametric, 4 bands per channel/notch filtering
- Presets for all Alcons system configurations
- Exchangeable with SDP (analog) modules in ALC

A: Alcons Audio B.V.
De Corantijn 69
1689 AN Zwaag
The Netherlands

E: info@alconsaudio.com
W: www.alconsaudio.com
T: +31 (0)229 28 30 90
F: +31 (0)229 28 30 99